

Capillary Gas Chromatograph

GC-2010 Plus



GC-2010 Plus

With Advanced Flow Technology

CAPILLARY GAS CHROMATOGRAPH SYSTEM

The Shimadzu GC-2010 Plus represents a new generation in top end capillary GC analysis, redefining sensitivity limits for trace analysis, fast GC applications, and easy, robust operation. Advanced Flow Technology (AFT) capability further extends the applications scope of the instrument allowing multidimensional GC, capillary backflush, and other specialized flow applications. AFT additionally enables reduced analysis times, enhanced chromatographic resolution, and application-specific configurations without compromising key performance features. The new detector line-up, featuring sensitivity specifications among the highest in the industry, ensures quality data across a broad range of applications.



Advanced Flow Technology ▶ P.4

- Multi-dimensional system
- Backflush system
- Detector splitting system

Leading Sensitivity ▶ P.8

- Best-in-class*high-sensitivity detectors

Enhanced Productivity ▶ P.11

- High-speed analysis
- Backflush
- Rapid oven heating/ cooling
- Gas saver function
- Excellent repeatability
- Carrier gas constant linear velocity mode
- Dual-injection system

Data Management [LabSolutions] ▶ P.16

- Easy operation
- Improves productivity
- GLP/GMP compliant
- Network compliant

Applications ▶ P.22

- Thermal decomposition analysis
- Liquid Injection/ Headspace/ SPME Analysis system
- Pyrolysis system
- Distillation GC System
- PONA analysis

*Per survey result as of April 2009

**For speed, precision and accuracy,
the GC-2010 Plus has just raised
the bar....again!**



Advanced Flow Technology

Advanced Flow Technology is Shimadzu's solution to provide enhanced separation power and operational efficiency for applications with complex sample matrices. This enhanced capability is based on the high precision Advanced Flow Control (AFC) of the GC-2010 Plus.

Advanced Flow Technology for high-performance separation

Multi-dimensional GC/GCMS System MDGC/GCMS-2010



A multi-dimensional GC/GCMS system performs separations using two columns that have different chromatographic selectivity. When components of interest are insufficiently separated on the first column, they can be selectively introduced ("heart-cut") to a second chromatographic column with different selectivity. This enables enhanced chromatographic separation that cannot be attained in conventional single-column analysis. In addition, the precise flow-switching technology, which is supported by a high-precision digital flow controller, ensures heart-cut analysis with the high level of reproducibility demanded of complex capillary GC separations.

Multi-Deans' Switching

In the past, multidimensional GC has been accomplished using a switching mechanism known as Deans' Switch. However, this system results in such problems as a reduced recovery (sample loss) and fluctuations in retention time after column switching. The MDGC/GCMS-2010 system incorporates multi-Deans switching, a new mechanism that significantly reduces the likelihood of fluctuations in the retention times of components eluted after column switching, even when column switching is performed several times.

• Standby Mode

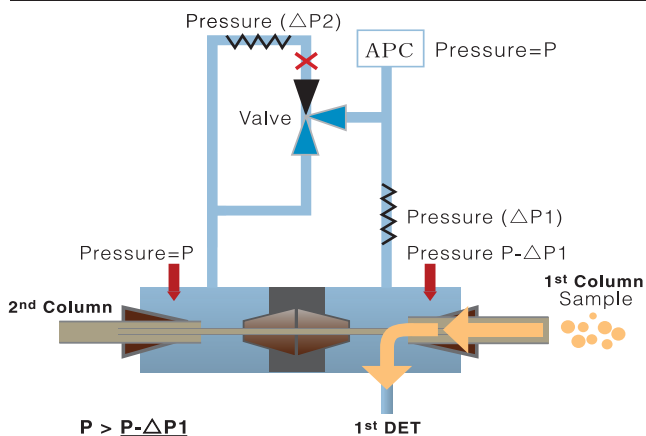

• Cut Mode

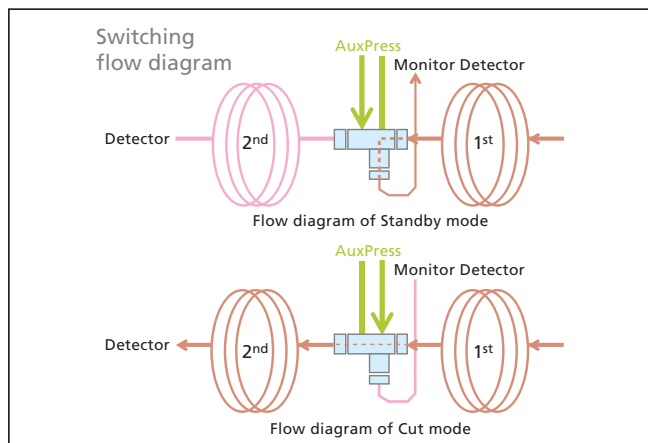
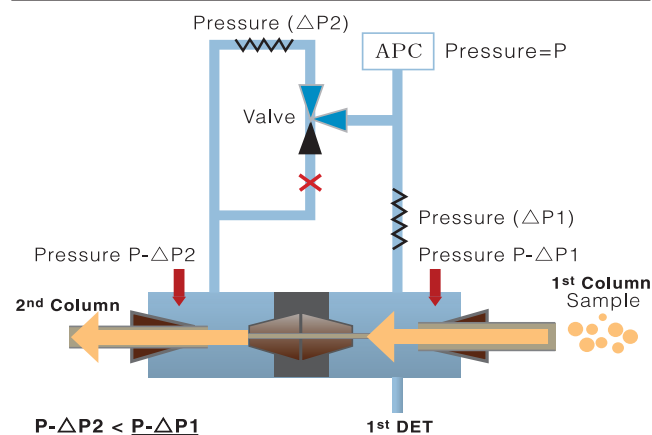

Multi-Switching Analysis of Essential Oil

1st Column : MEGA SE-52 0.25 x 25 m df=0.25 μ m
 Oven temp : 50 °C - 280 °C (3 °C/min)
 Injector : 250 °C
 Split ratio : 1 : 100
 Monitor FID : 290 °C
 Hz: 50 mL/min, Air: 400 mL/min, Make-up: 0 mL/min
 Switching : 8 times
 2nd Column : MEGA DetTBuSililBeta 0.25 x 25 m df=0.25 μ m
 Oven temp : 45 °C (12.00 min) - 180 °C (2 °C/min)

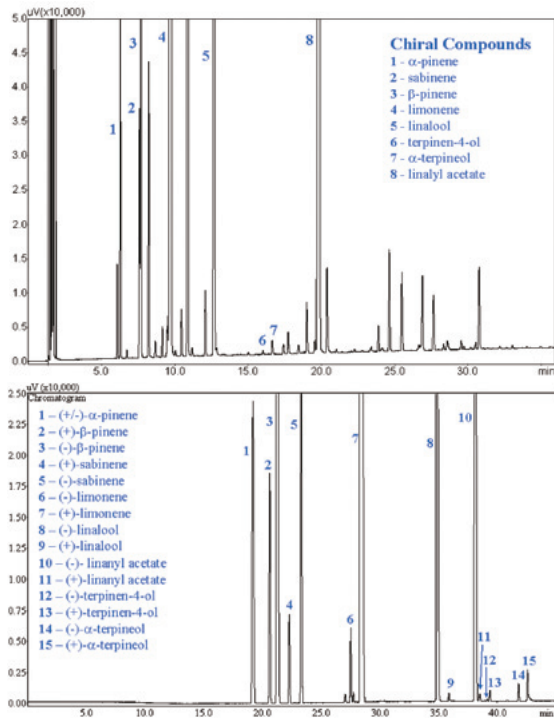

Data by
 Università degli Studi di Messina
 Prof. Luigi Mondello
 Alessandro Casilli
 Peter Quinto Tranchida
 Danilo Sciarrone

Chromatogram Obtained with 1st Column

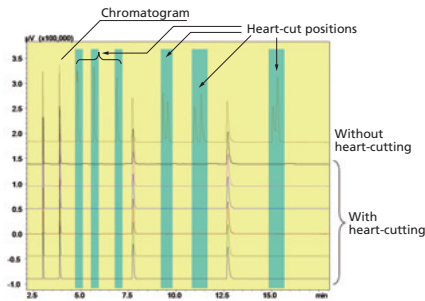

Reproducibility of 1st Column

Compound	Area		Retention Time	
	MeOH	tAmOH	MeOH	tAmOH
1	174308	435368	3.008	12.712
2	171031	427495	3.009	12.712
3	173117	433085	3.009	12.712
4	174715	438180	3.009	12.712
5	172315	430744	3.008	12.712
6	174633	436304	3.008	12.712
7	175269	439073	3.009	12.712
8	175863	441410	3.008	12.711
9	172717	430224	3.008	12.712
10	172002	435496	3.008	12.712
Average	173597	434738	3.008	12.712
STDEV	1582	4347	0.00052	0.00032
CV(%)	0.912	1.000	0.017	0.002

Chromatogram Obtained with 2nd Column

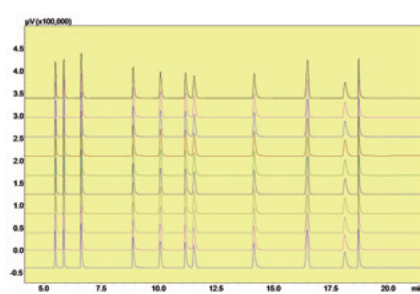

Reproducibility of 2nd Column

Compound	Area						Retention Time					
	Acetone	IPA	ETBE	Bz	TAME	nBuOH	Acetone	IPA	ETBE	Bz	TAME	nBuOH
1	241902	258122	322917	584033	302735	341100	5.515	5.880	11.563	16.501	18.137	18.733
2	237073	253283	316835	572472	296948	334684	5.516	5.880	11.565	16.501	18.136	18.734
3	240294	256361	321149	580369	301337	339373	5.516	5.881	11.565	16.503	18.138	18.733
4	242492	259231	324511	587335	304680	343516	5.515	5.881	11.565	16.502	18.136	18.732
5	238727	254946	318735	576768	299044	337067	5.515	5.880	11.563	16.500	18.136	18.733
6	242091	258606	323204	584763	303246	342028	5.515	5.880	11.563	16.503	18.137	18.732
7	243402	260304	325211	588083	305140	344235	5.515	5.880	11.563	16.502	18.135	18.731
8	241572	260384	326286	588626	301903	337481	5.515	5.880	11.563	16.501	18.135	18.732
9	239256	255374	319324	576796	299153	336898	5.515	5.880	11.563	16.501	18.135	18.733
10	238508	254885	319167	576955	299617	337750	5.515	5.880	11.564	16.502	18.137	18.730
Average	240532	257150	321734	581620	301380	339413	5.515	5.880	11.564	16.502	18.136	18.732
STDEV	2067.56	2506.10	3159.04	5706.12	2662.17	3170.38	0.00037	0.00049	0.00067	0.00076	0.00108	0.00106
CV	0.860	0.975	0.982	0.981	0.883	0.934	0.007	0.008	0.006	0.005	0.006	0.006

Advanced Flow Technology for Enhanced Productivity and Confident Identification

Backflush System

The backflush system reverses the carrier gas flow after the target compounds have eluted, to discharge residual late eluting components in the column through the injection port split vent.

Backflush shortens the analysis time and improves productivity. In addition, high-boiling point components are discharged efficiently to reduce the bakeout time (elution time), and thus prevent column deterioration, contamination, and retention time shifts.

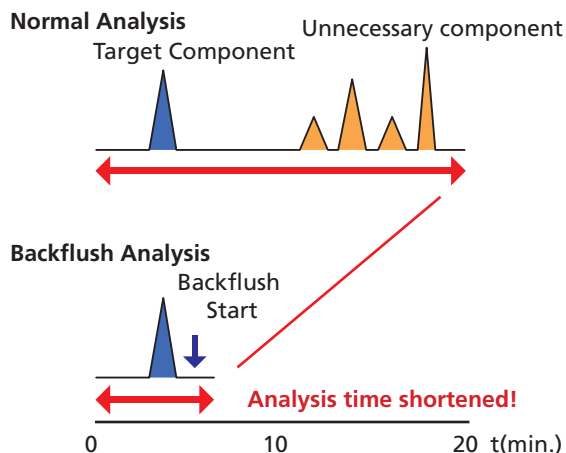

Detector Splitting System

Compounds eluting from an analytical column may be split to multiple detectors to obtain multiple chromatograms. Offering abundant information in a single analysis, this system saves time and money. In addition, with concurrent use of selective detectors, confidence in peak identity is improved. We recommend this system to GCMS users wanting to confirm compound classes using detector selectivity.

For analysis of natural products such as flavor compounds, it is efficient to use a combination of FID and MS. FID has a wide dynamic range for quantitative analysis, while MS has unmatched capability for qualitative identification. Using the detector splitting system, a TIC (Total Ion Chromatogram) and an FID chromatogram of the same pattern can be obtained simultaneously with one analysis.

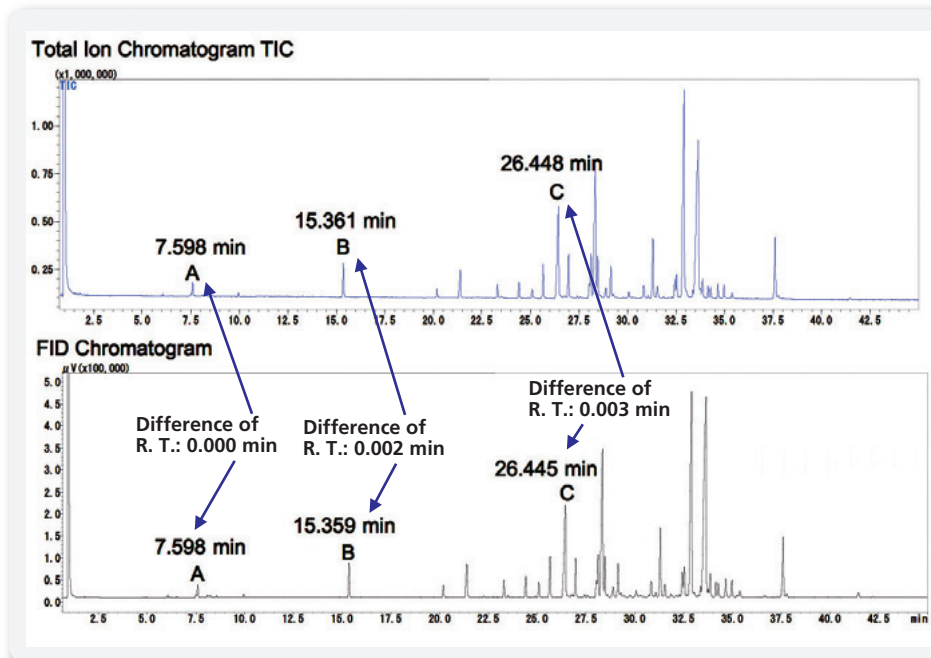

Qualitative analysis by MS

Quantitative analysis by FID:
Wide quantitation response range

AFT Software

The Intuitive and easy-to-use Advanced Flow Technology Software is included with each AFT system. Both the backflushing and detector splitting systems are controlled with this software.

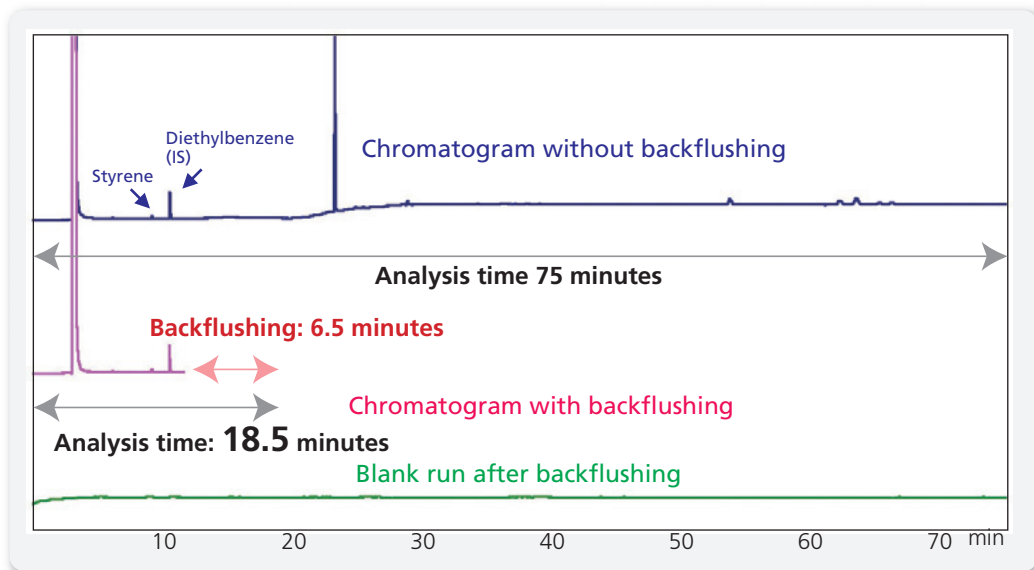

Analysis of Volatile Compounds in Polystyrene

Backflushing was started 12 minutes after target substances were eluted. Analysis time, including the time for discharging unwanted substances, could be reduced from 75 minutes to 18.5 minutes.

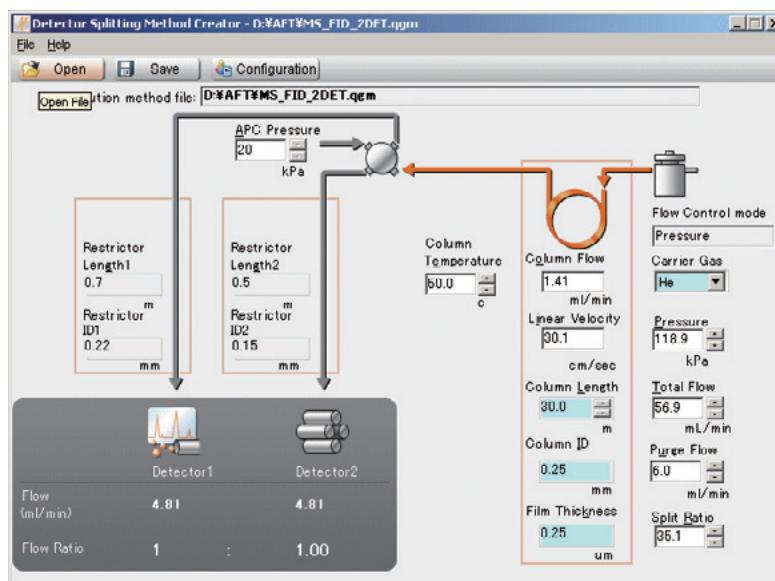

Advanced Flow Technology software download site
<http://www.shimadzu.com/products/lab/gc/index.html>

Industry Leading Detector Sensitivity

Responding to the ever increasing demands for trace level analysis, our new detectors boast the highest sensitivity in the industry. The new Flame Photometric Detector (FPD) and Flame Ionization Detector (FID) show significantly increased sensitivity.

Flame Ionization Detector

FID-2010 Plus

Minimum Detected Quantity: 1.5 pgC/s*

FID-2010 Plus gives you the world's highest FID sensitivity with clean detector gas flows and the latest noise reduction technology.

- High-sensitivity has been achieved by thorough cleaning of detector gas lines and the latest noise-reduction technology.
- Automatic ignition, re-ignition, and flame extinguishing functions
- Feedback function reduces gas supply pressure to zero when the hydrogen flame is extinguished.
- Hydrogen connector joints have reverse threads to prevent incorrect pipe connections.
- Optional flame monitor can be mounted.

*For high sensitivity analyses, high purity air (Impurity of hydrocarbons <1 ppm) is required. (Tubing and gas pressure regulator must be compliant with high-purity gas use.)

Analysis of n-C12, 14, 16 / n-heptane solution

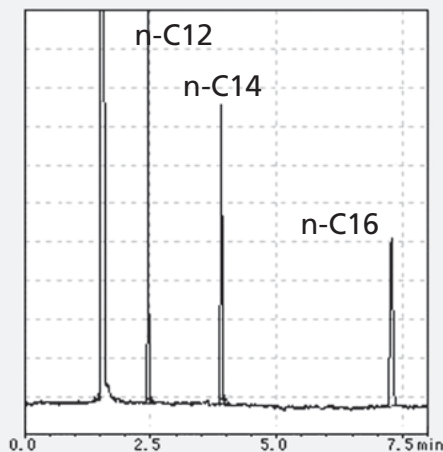

FID-2010 Plus

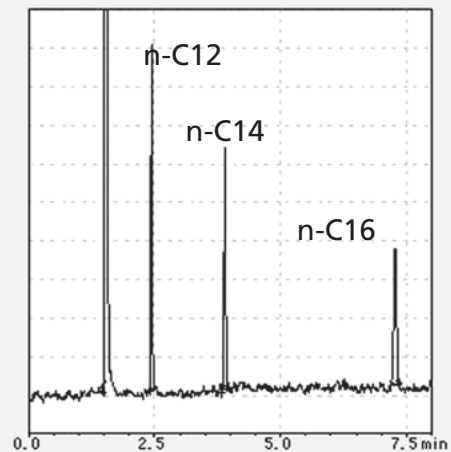

conventional model

Flame Photometric Detector

FPD-2010 Plus

A new FPD design featuring improved flame stability and double focusing optics has produced an FPD with the world's highest sensitivity. This has all been achieved in a compact design that fits within the detector bay.

The dual-focus system adds a lens to the interference filter for efficient light collection at the photomultiplier light receptor.

Minimum Detected Quantity:
55 fgP/s (phosphorus compounds)
3 pgS/s (sulfur compounds)

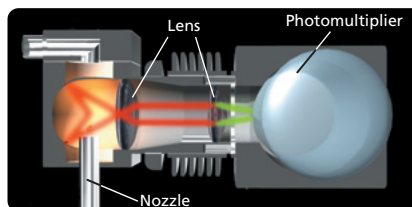

P mode: Analysis of 5 ppb Organo-Phosphorus Pesticides

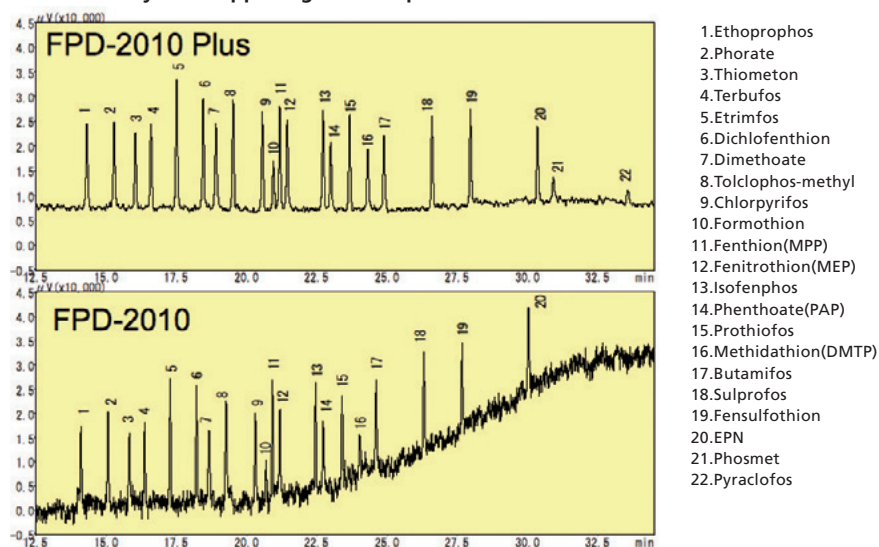

S Mode: Analysis of 20 ppb Thiophene in Benzene

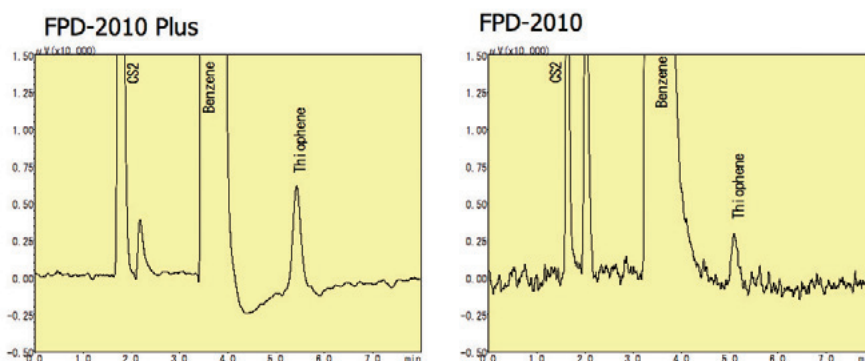

Industry Leading Detector Sensitivity

Electron Capture Detector*

ECD-2010 Plus

Minimum Detected Quantity: 6fg/sec

- A highly sensitive and selective detector for the analysis of electrophilic compounds.
- Top class sensitivity results from upgraded cell insulation and a cell/flow line design to reduce contamination.
- Compact design achieves shorter stabilization times.
- ECD cell is common with that for GC-2010 (ECD-2010).

*In some countries, registration with the appropriate authority for regulation of radioisotopes is required before purchasing or using this detector. (Contact your Shimadzu representative for details.)

Thermal Conductivity Detector

TCD-2010 Plus

Sensitivity: 20000mV mL/mg(decane)

- For analysis of gases and concentrated organic compounds.
- Microvolume cell optimized for capillary column analysis.
- Short stabilization time.

Flame Thermionic Detector (NPD)

FTD-2010 Plus

Minimum Detected Quantity: 0.1pgN/sec

- For analysis of organo nitrogen and phosphorus compounds, such as residual pesticides.
- Improved collector design reduces negative peaks from impurity components.
- No tools needed for collector replacement.
- Alkali source regeneration kit (option) reduces operational costs.
- Hydrogen connector fittings have reverse threads to prevent pipe connections.

Improved Collector of FTD-2010 Plus Reduces Negative Peaks.

Improved collector – zoom

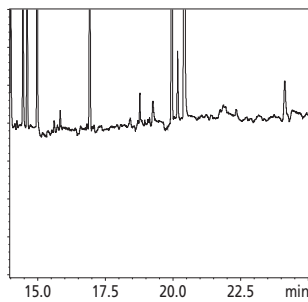

Standard collector – zoom

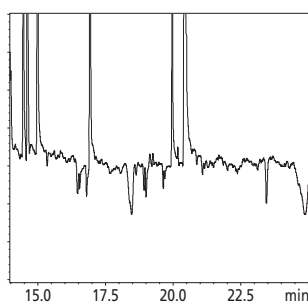

Highly Evolved Design Delivers Analytical Productivity

High-Speed Analysis

High-speed analysis with narrow bore capillary columns reduces analysis time and improves sample throughput. The new-generation digital flow rate controller (AFC) provides 970 kPa maximum operating pressure and 1200 mL/min total flow to support high-speed analysis.

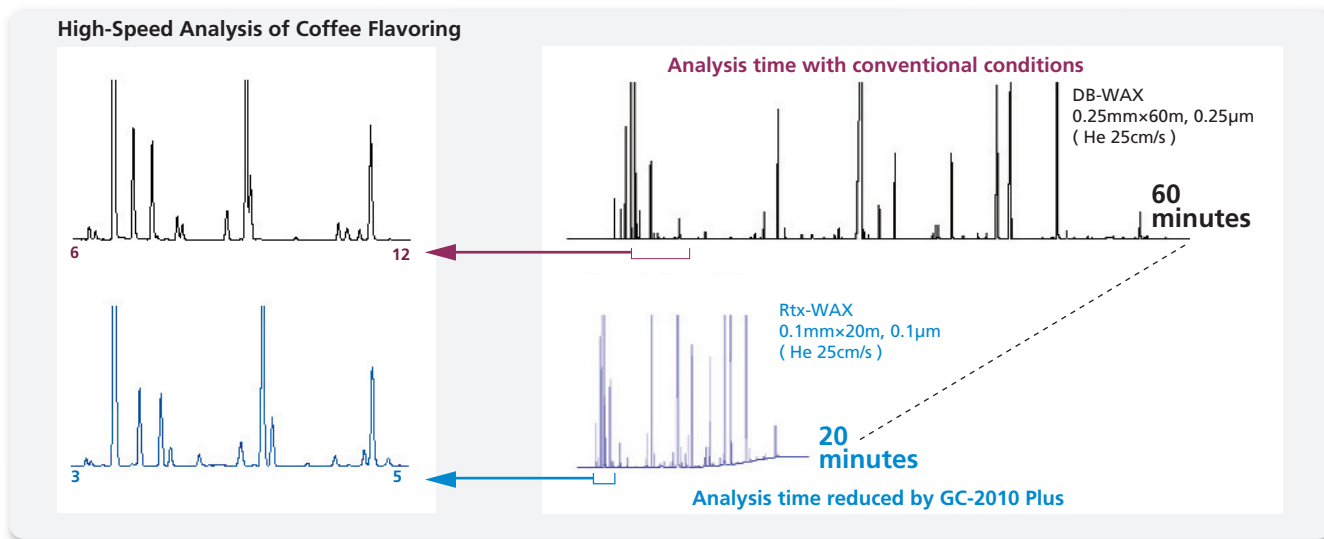

Backflush Reduces Analysis Time

The Backflush technique is effective in capillary GC analysis when early-eluting target compounds occur in a sample along with higher boiling components not of interest to the analysis.

Analysis of Pesticides in Cabbage

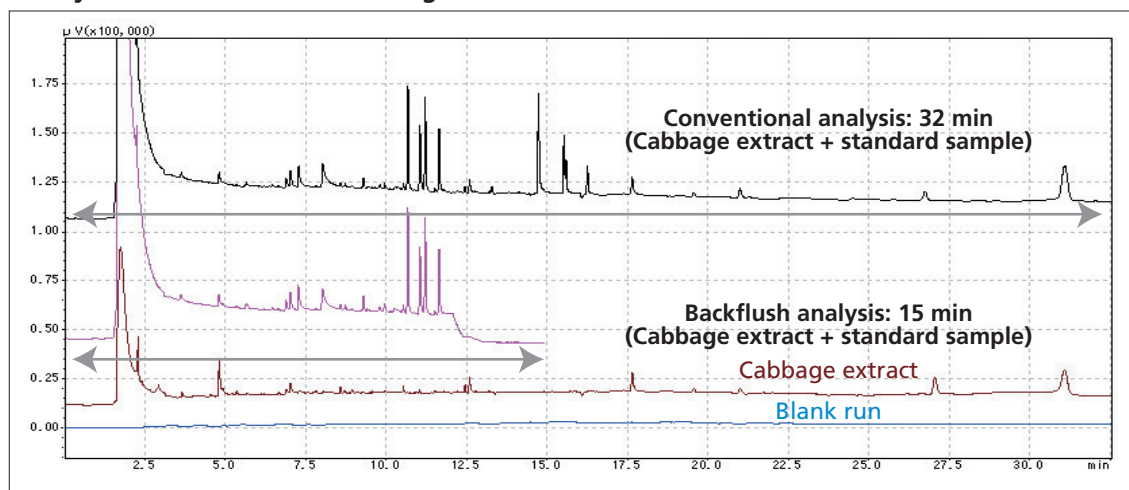

Reduction of analysis time by 53%

Rapid Oven Heating*/ Cooling

The GC-2010 Plus incorporates a double-jet cooling system, consisting of an exhaust fan to discharge hot air and an intake fan to draw in cooling air. The system enables the reduction of cooling time from 450°C to 50°C in 3.4 min.

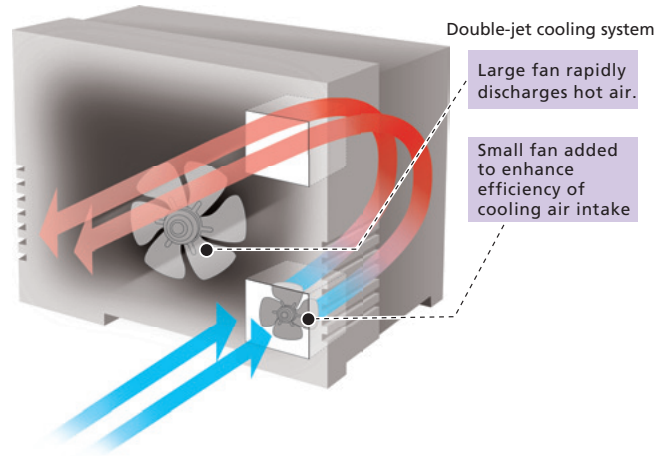
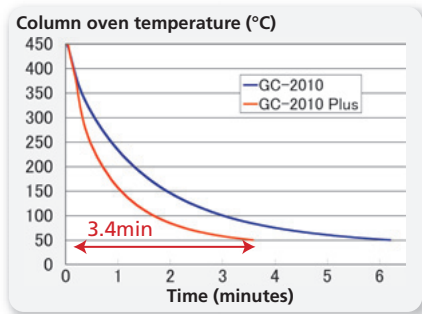

Hydrocarbon analysis in conventional mode

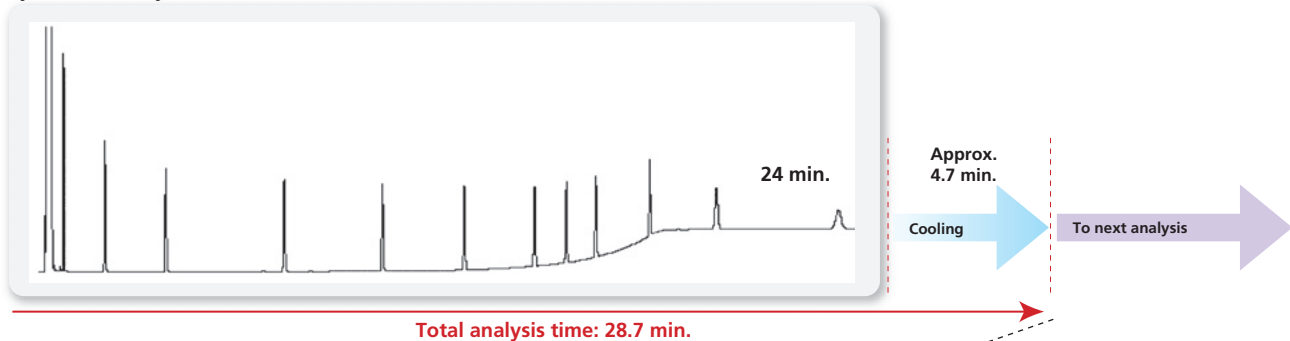

Hydrocarbon analysis with GC-2010 Plus high power oven model (230V)

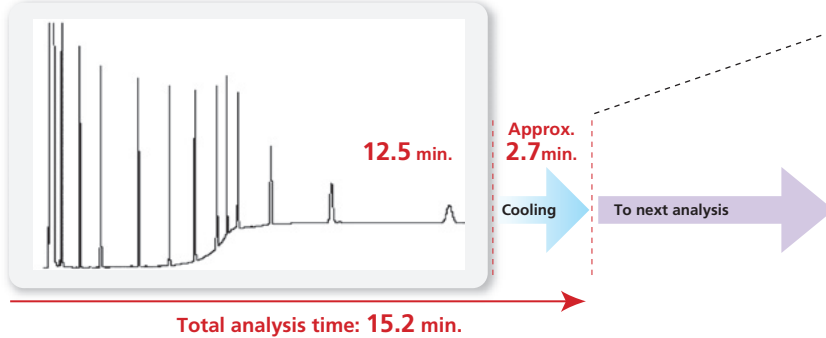

*Rapid oven heating is available with the high power oven (230V model) only.

Repeatability Resetting the Limits

All units including the column oven, flow controller, and sample injection unit are comprehensively optimized at the design stage to achieve world-class precision.

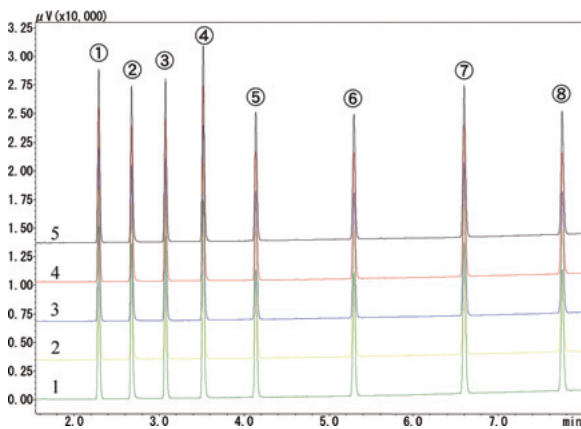

Analysis of Grob Test Mixture (Solvent: acetone, each 100 ppm)

The large vaporization capacity ensures excellent precision, even when using solvents that are highly volatile upon injection, such as acetone. Long-term stability of retention time is realized by the new room temperature compensation technology built into each AFC (Advanced Flow Controller).

Repeatability of Retention Time and Area

	Average RT	CV% RT	Average Area	CV% Area
1. n-Decane	2.29436	0.0043	23429.8	0.1870
2. n-Octyl Alcohol	2.68199	0.0031	22252.9	0.3020
3. n- Undecane	3.08074	0.0023	23997.2	0.2236
4. 2,6-Dimethylaniline	3.52498	0.0045	29616.6	0.2502
5. Methyl n-Nonanoate	4.14567	0.0041	20563.3	0.2262
6. Methyl n-Caprato	5.30144	0.0042	21484.8	0.0744
7. Dicyclohexylamine	6.60017	0.0017	28067.3	0.1894
8. Methyl Laurate	7.75542	0.0024	22759.5	0.1638

Gas Saver Function Reduces Carrier Gas Usage

The GC-2010 Plus features a gas saving function that considerably reduces carrier gas consumption. In the split/ splitless sample injection mode, the split ratio can be reduced after injection and during stand-by.

Simultaneously install up to three injection units and up to four detectors

Select from three injection units and five detector types to suit the needs of your analysis. Options such as injection units, detectors and autoinjectors can easily be retrofitted.

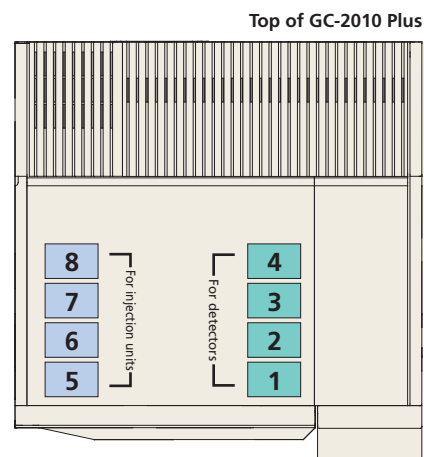

Split/Splitless Injector

SPL-2010 Plus

- New design reduces the possibility of carry over.
- Standard configuration supports high-speed GC with narrow bore capillary columns.
- Gas saver function reduces split gas consumption.
- Permits high-pressure injection mode.

On-Column/Programmed Temperature Vaporization Injector

OCI/PTV-2010

- Configured for either cool, on-column injection (OCI) or programmed temperature vaporization (PTV) injection mode.
- Uses inert quartz PTV inserts.
- An optional OCI insert allows connecting a narrow-bore capillary column directly to the injector without a 0.53mm pre-column.
- Supports analysis of very high-boiling compounds (alkanes up to C₁₀₀).

Direct Injection Unit

WBI-2010 Plus

- Septum purge flow channel prevents solvent tailing.
- Uses the same glass inserts as splitless analysis to simplify use. (Patented)
- * Easily modified for packed column use.

SPL-2010 Plus

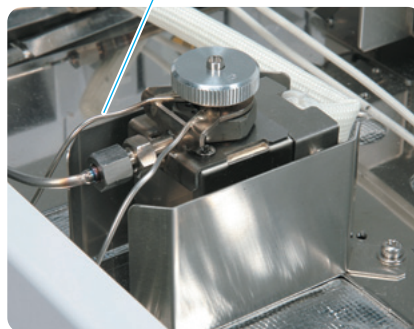

OCI/PTV-2010 WBI-2010 Plus

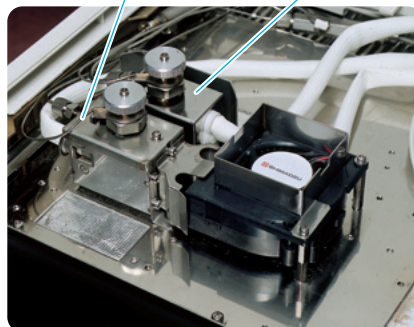

Dual Injection System

A dual injector system can be configured with a combination of two AOC-20i injectors and one AOC-20s sample carousel. Two-line simultaneous injection doubles the sample throughput to improve productivity.



Constant Linear Velocity Mode Quickly Determines Separation Conditions

Shimadzu's approach to carrier gas control is based on the carrier gas linear velocity, which directly correlates to the separation performance. Method transfer from GC to GCMS or helium to hydrogen carrier is greatly facilitated.

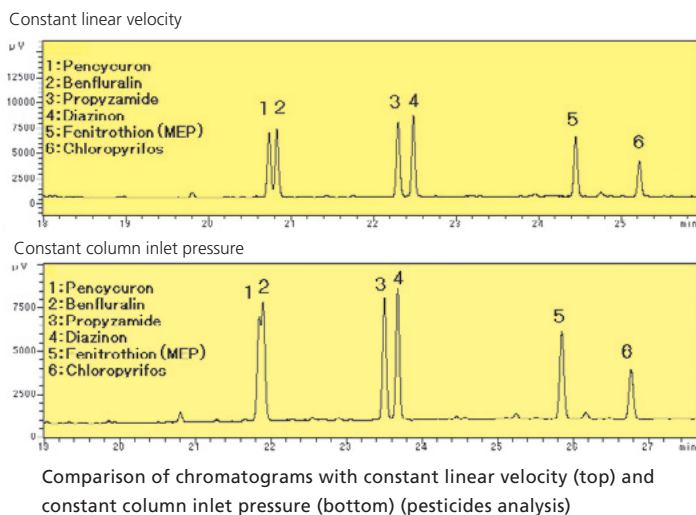

Using the same type of column and setting the same carrier gas linear velocity values results in a virtually identical separation profile for GC and GCMS.

Comparison of GC-FID and GC/MS-TIC Chromatograms (Grob Test Mixture Analysis)

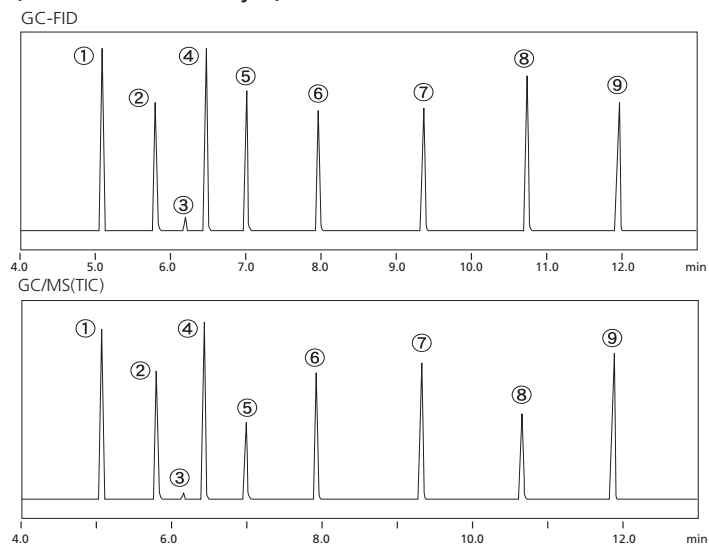

Shimadzu Gas Chromatograph Work Station

LabSolutions Version 5 Powerful LabSolutions Software for Increased Productivity and Easy Operation

The LabSolutions series is the next-generation workstation software that integrates GC control, LC control, and other improvements in functionality, while maintaining compatibility with previous GCsolution products. It offers sophisticated functionality, easy operation, and highly expandable and customizable report functions. In addition to inheriting these and other concepts from GCsolution, LabSolutions shares a common operating environment.

Easy Operation

- LabSolutions offers both ease of operation and extensive functionality by utilizing a common operating environment shared throughout the LabSolutions series, including such features as an Assistant Bar and Data Explorer, to provide a user interface that can be operated intuitively and learned in a short time.
- The new data browser is convenient for comparing multiple sets of data by enabling access to chromatograms, peak information, and quantitation results from multiple data files at the same time.
- Windows for operating the instrument and assistant bar panels for navigating operations can be customized according to the workflow where the system is being used.

Better Analysis Productivity

- Handles control and data processing for up to four GC systems (up to 16 GC systems can be registered).
(GC-2010 Plus, GC-2010, GC-2014, GC-14B, AOC-20i/s)
(Note: Not compatible with distillation GC software, PONAsolution, MDGCsolution, or Advanced Flow Technology software. Please use the previous GCsolution products. Refer to the Shimadzu GC-2025 brochure (C184-E026) for detail of the GCsolution)
- Supports simultaneous processing of two samples on a single instrument and a dual injection system.
- Automatically controls all phases of operation, from startup and system check, to baseline check, system suitability test, associated automatic pass/fail judgment and action functions, and shutdown, to minimize the work required for analysis.
- Simultaneously controls GC and LC systems from a single computer. Integrating the operating environment for GC and LC analysis reduces the time required for analyst training.

Comprehensive Basic Functions

- Inherits the popular, proven and robust Chromatopac and GCsolution integration algorithm.
- Comprehensive functions for peak identification, quantitation, and data comparison.
- Flexible report generation functions with operation similar to MS Word.
Summary report output is possible.

GLP/GMP Regulatory Compliance

- Full support of user-management functions and GC-2010 Plus self-diagnostic functions to enhance data reliability. Supports rigorous GLP/GMP requirements, including audit-trail functions for all method parameters.
- System management functions, such as system policy settings, user management, log browser, and audit trail functions, provide full functionality for compliance with U.S. FDA 21 CFR Part 11 (regulations regarding electronic records and electronic signatures).

Network Compatibility

- Enables effective use of a network environment, such as with in-office data analysis and remote access functions.
- CLASS-Agent enables file sharing and centralized data management.

User Interface

The latest Windows technologies, with a user interface that includes drag-and-drop and right-click menus, offer multi-functionality and simple, quick, intuitive operation.

Easy-to-Operate Assistant Bar and Data Explorer

- Navigate operations with Assistant Bar. Even novices can easily conduct analysis or re-analysis simply by sequentially clicking on icons.
- Data Explorer displays a list of files by type. Intuitively handle file operations by double-clicking or drag-and-drop.

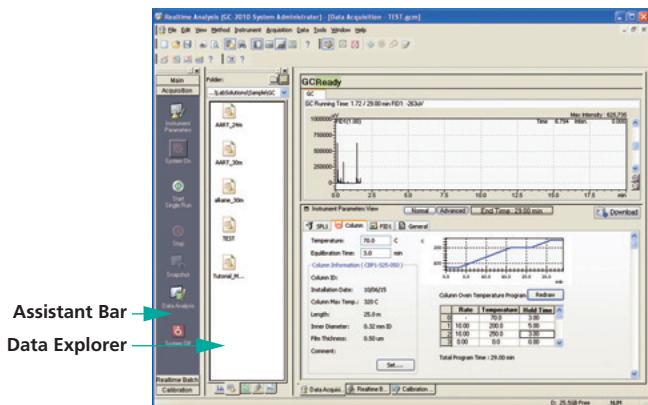

Even Confirming Multiple Analytical Results Is Easy with the Quant Browser

- The quant browser displays the large amounts of analytical data and calculated quantitation results obtained simultaneously from batch analyses to allow more efficient analysis.
- Since each chromatogram and quantitation result is linked to respective rows in the Quantitative Results Table, the necessary information about each component in the data files can be accessed easily by selecting a row in the table.
- It is also easy to change peak integration parameters or other parameters to perform post-run analyses or re-plot calibration curves for multiple datasets at the same time.

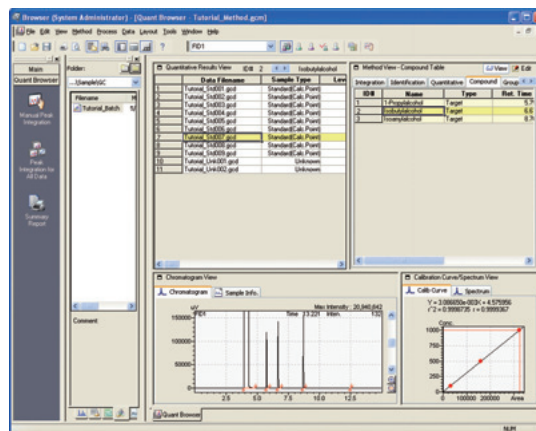

Batch Table Wizard Simplifies Consecutive Analyses

- Easily create batch tables for consecutive analysis of multiple samples using the Wizard.
- Simply fill in the prompts in the Wizard to create multi-point calibration curves and batch tables for repeated analyses.

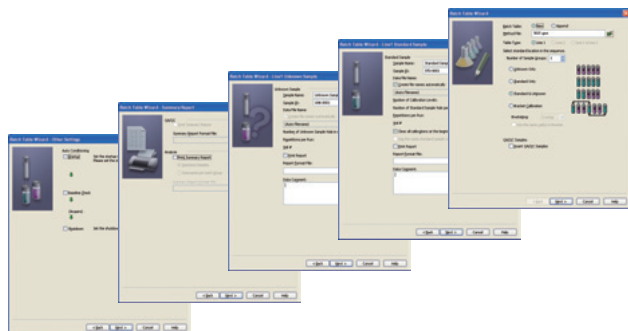

Shimadzu Gas Chromatograph Work Station

Data Analysis/Report Generation

Builds on the popular Chromatopac and GCsolution basic functions, including integration algorithms. Offers comprehensive functions for identification, quantitation, data comparison, and report generation.

Identification and Quantitation Functions Offer Full Assortment of Calibration Curve Types and Operations

- Support for six quantitation methods, such as external and internal standard methods, and seven types of calibration curves, including linear, point to point and polynomial fits, ensures compatibility with an extensive range of requirements.
- Calibration curves can be created by dragging and dropping data files into the calibration window.

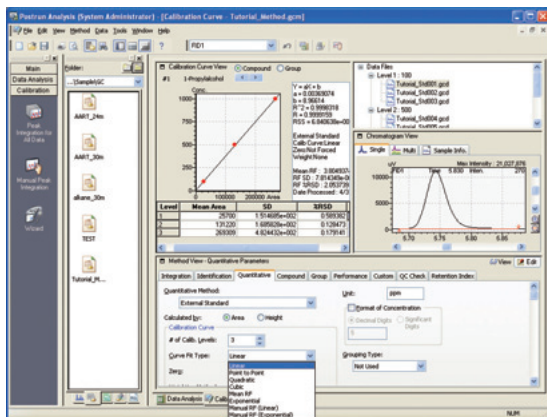

Data Comparison Function

- Display and compare up to 16 chromatograms.
- Convenient for comparison of previous data and investigation of changes in time-course data.
- Select superimposed or split-screen display.
- Conduct detailed analysis using addition, subtraction, differential, and second-order differential operations.

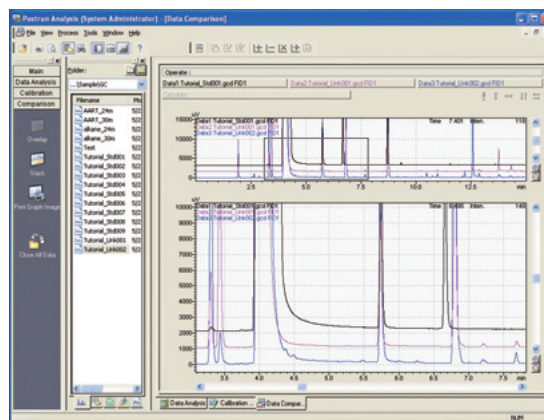

Flexible Report Generation Functions

- Highly flexible report generation.
- Paste and freely edit chromatograms, peak tables, and other report items.
- Save report formats as templates.
- LabSolutions includes a PDF output function to allow outputting analytical reports as PDF files, which helps promote a more eco-friendly paperless laboratory.

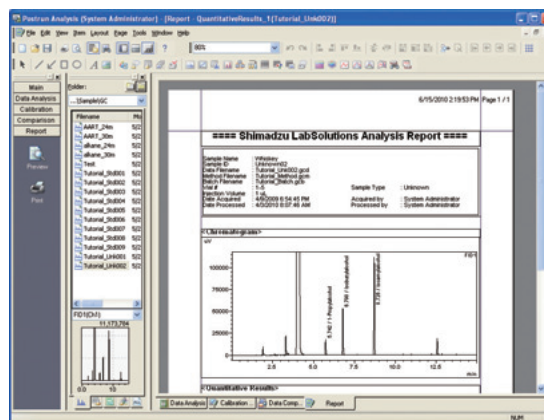

GLP/GMP Regulatory Compliance

To be compliant with management requirements and regulations such as GLP/GMP, a variety of sophisticated demands related to: analyzer reliability, method development, analysis method validation, and electronic file management must be satisfied to ensure data integrity. LabSolutions strongly supports GLP/GMP with various validation functions, user-management functions and so on. In addition, 21 CFR Part 11 compliance support functions are also available(option).

User Management Functions to Control User Access

- Limit user access to operations by Test manager and Operator default user groups.
- Add or edit groups to create security that matches your laboratory workflow.

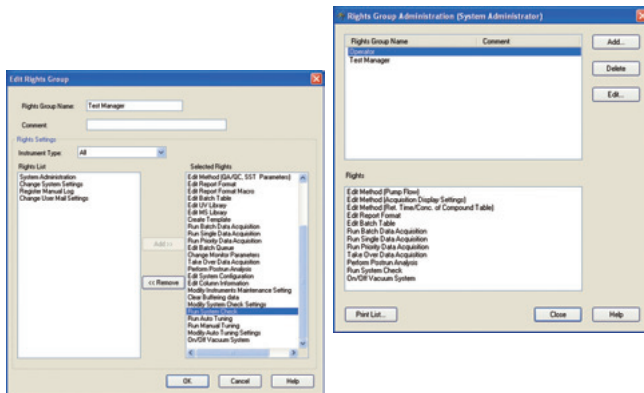

Validation Support

- Fully supports the GC-2010 Plus self-diagnostic functions. Periodic checks of the GC status support superior analysis and greater confidence in your results.
- Includes software validation functions to check for software modifications.
- Includes QA/QC functions that enable pass/fail judgments based on repeatability of component concentrations, recovery rates, and concentration upper and lower limit checks, and system suitability functions to perform various statistical calculations, such as component concentrations, averages of peak areas and other values, standard deviations, and %RSD values.

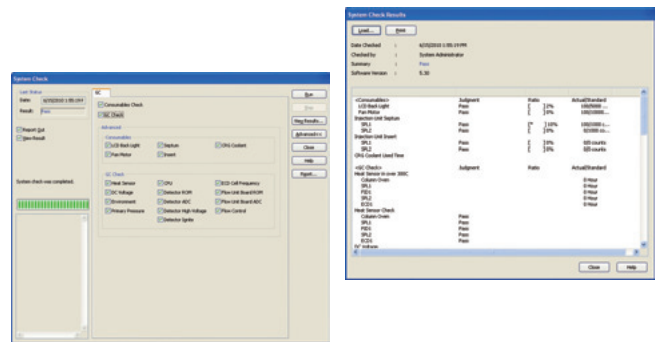

Customization Functions Provide an Optimized Operating Environment Tailored to the Workflow

- Allows customizing the main launcher instrument selection menu, assistant bar, tool bar, and application window. Numerical formats and rounding processes for areas, heights, concentrations, column performance calculation results, and other values can be defined for the entire system.

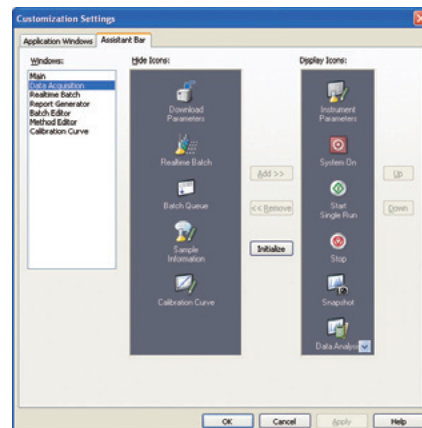

Network Capability

Using a network, such as an internal LAN, allows sharing data, analysis methods, and other file information and managing data in a central location. In addition to serving its fundamental role as workstation software, LabSolutions also offers a range of network tools to improve analytical productivity.

CLASS-Agent Data Management System

- Software for centralized data management
- Measured data automatically saved in the database
- Browsing software easily finds target data
- Browse data over the Internet
- Compatible with Oracle, Access, and SQL databases

LabSolutions Post-run Software

Install the secondary license software in a separate PC on the LAN to allow data analysis in the office.

GC-LAN Connection Kit

- Offers remote GC control and data acquisition in a LAN environment
- Connects the GC to PCs over a LAN using a LAN adaptor

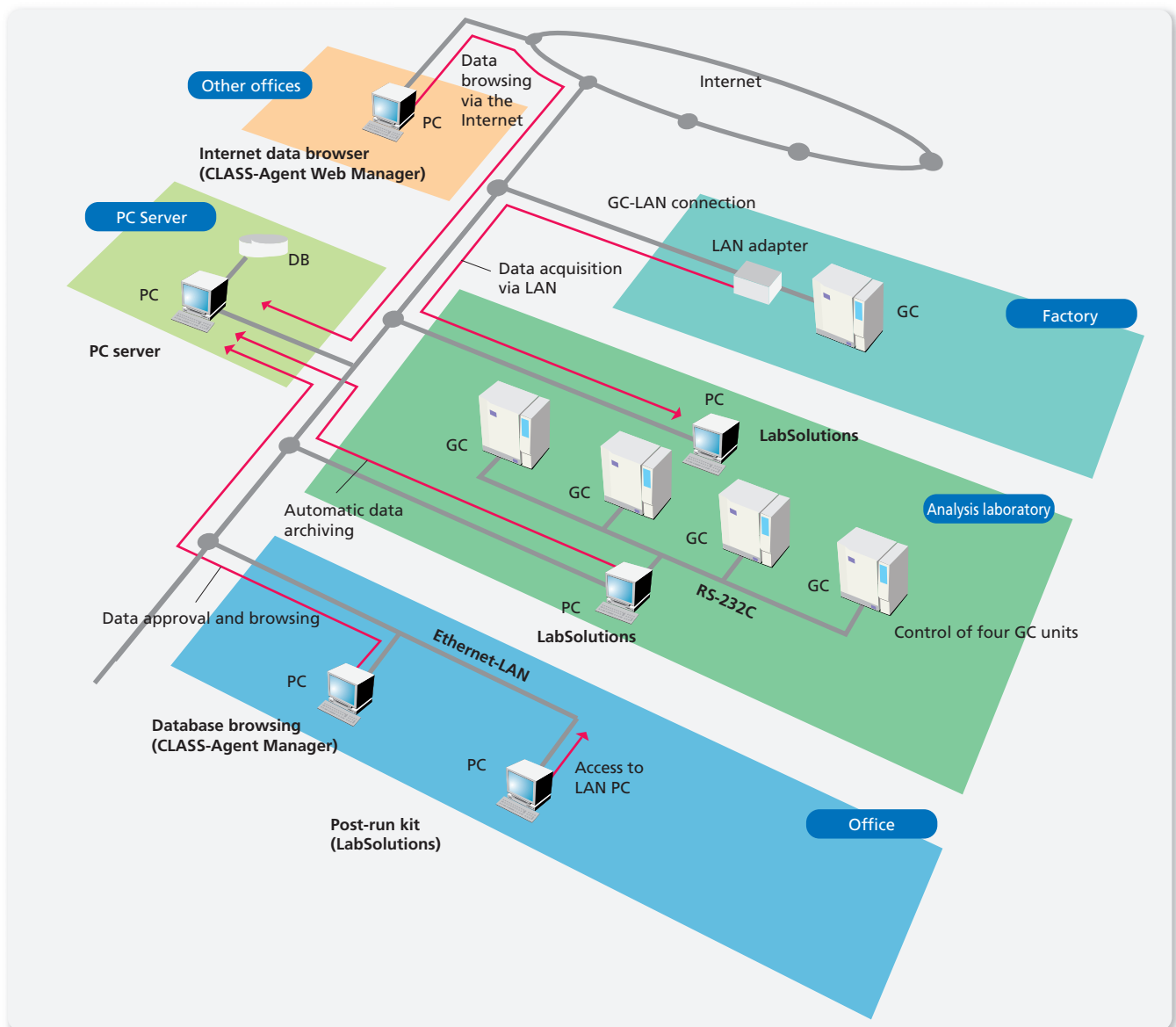

LabSolutions Ver. 5 Specifications

Software Specifications

Compatible with Windows®7 Professional / XP Professional (SP2 or SP3) / Vista Business (SP2)

32-bit application (capable of long filenames)

Graphical user interface (assistant bar, etc.)

Instrument Control

Controls GC-2010 Plus, GC-2010, GC-2014, GC-14B (A), AOC-20i/s.

Simultaneously controls a maximum of four GC or LC units (multi-license version permits registering up to 16 units).

Supports dual-injection system and a maximum of four GC-2010 detectors or two non-GC-2010 detectors.

Data Acquisition

Offers minimum sampling time of 4 ms, snapshot function, single analysis and batch analysis capability, Batch Table Wizard, analysis add or insert function, extended analysis time function, automatic data file name creation, QA/QC (statistical) functions, batch auto-stop function, user program launcher function, pre-run program support, and OLE automation compatibility (for batch analysis, etc.).

Data Processing and Data Analysis

Automatic and manual peak integration, manipulation, identification (supports multiple relative retention times and grouping), quantitation (area normalization method, corrected area normalization method, internal standard method, external standard method, standard addition method, index calculation, manual coefficient input), calibration points and levels (16 levels 10 points), manual calibration curve creation, column performance calibration, data comparison functions, relative retention time (RRT) display, retention time correction (AART)

Report Generation

Over ten types of report items (sample information, configuration settings, methods, chromatograms, peak tables, calibration curves, grouping results, diagrams, text, etc.), layout customization and preview functions, summary report

Files

Data Explorer for file management, All-In-One file structure, file conversion (CLASS-GC10 format, AIA ANDI format, and text format), GC/LCsolution file loading, file searching, template functions

Hardware Functions

Shutdown/startup functions, system check (GC self-diagnosis), status log, system suitability test (SST) functions

GLP/GMP Compliance

Audit trail, software validation, security, Part 11 compliance functions

Network Capability

GC-LAN connectivity (optional LAN adapter)

Other

Maintenance guide (GC-2010 Plus, GC-2010, GC-2014, GC-17A/1700, GC-14A/B, AOC-20i)

Please refer to the Shimadzu GC-2025 brochure (C184-E026) for specification of GCsolution

Example of LabSolutions PC Configuration

PC:

CPU: Intel Pentium processor E5700 3.0 GHz, RAM: 2 GB, HDD: 160 GB
Super multi-drive, OADG keyboard, 1000BASE-T/100BASE-TX/10BASE-T LAN interface

Operating Software

Windows 7 Professional
LabSolutions Ver. 5.42 SP2
CLASS-Agent Manager Ver.2.33
Adobe Acrobat Reader (Read only. Cannot create PDF files)

Liquid Crystal Display: 22-inch Wide Screen TFT LCD

RS232C Cable 2 m (228-35397-92): 1 (Single GC) or 2 (Multi GC)

- LabSolutions Single GC can control one GC unit. To control two or more GC units, use LabSolutions Multi GC.
- To control GC-14B(A) units, one CBM-102 interface is required for each GC unit.

Application systems respond to your analytical needs.

Advanced Flow Technology

Backflush System

Detector splitting system

Multi-dimensional GC/GCMS System
MDGC/GCMS-2010 Series

Application Systems

Thermal Desorption System

Liquid Injection/ Headspace/ SPME Analysis System

Pyrolysis System

Distillation GC System

PONA Analysis System



Thermal Desorption System

- Used to analyze gas sample tubes – organic vapors are collected on sample tubes at a sample site by drawing a large volume of air thru the tube over a long period of time.
- Sample tubes are thermally desorbed on the Thermal Desorption System to introduce the organic vapors into the GC.

System Configuration

- GC-2010 Plus + TD-20

Analysis Applications

- Measurement of air pollutants
- Measurement of gases generated from parts or materials (outgassing)
- Measurement of fragrance components



Liquid Injection/ Headspace/ SPME Analysis System

- Liquid, Large volume, Headspace and SPME injection in one single instrument.
- Used to analyze the volatile components in solid or liquid samples.

System Configuration (GC with headspace sampler)

- GC-2010 Plus + AOC-5000

Analysis Applications

- Measurement of residual solvents in pharmaceuticals
- Measurement of flavor components in foods
- Upgradable to SPME mode (solid micro extraction)



Pyrolysis System

- Decomposes samples at high temperatures and analyzes the pyrolytic decomposition products.
- Used to analyze high molecular weight compounds such as polymers, forensic samples etc.

System Configuration (GC with pyrolyser)

- GC-2010 Plus + Pyrolyzer by Frontier Laboratories Ltd.
- Autosampler and cryotrap accessories available.

Analysis Applications

- Characterization of high molecular weight compounds
- Measurement of outgassing from inorganic samples, such as ceramics

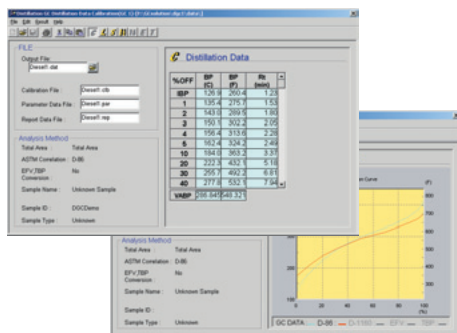

Distillation GC System

- Measures the boiling point distribution of petroleum fractions using the relationship between retention time and boiling point.
- Prints formatted reports after analysis of distillation characteristics.

System Configuration (Distillation GC)

- GC-2010 Plus + WBI-2010, or OCI-2010 + GCsolution + distillation GC software (Select sample injection unit and column to suit the target sample.)

Analysis Applications

- Petroleum fractions

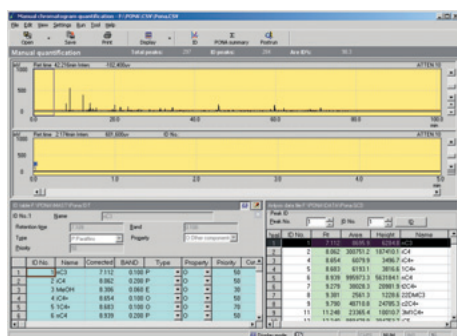

PONA Analysis System

- Separates gasoline or other hydrocarbon compounds; identifies the peaks; classifies them by carbon number, paraffin, olefin, naphthene, aromatic series and oxygenates. Outputs quantitative results.

System Configuration (PONA GC)

- GC-2010 Plus + CRG-2010 + GCsolution + PONA solution + MS Excel (Select sample injection unit and column to suit the target sample.) OCI and high-power oven (230V) are required for high-boiling point component analysis.

Analysis Applications

- Categorization of naphtha, gasoline and gasoline-based materials by carbon number and quantitation by type. (Also offers calculation of mean specific gravity, mean molecular weight, and octane value.)



Shimadzu Corporation
www.shimadzu.com/an/

Company names, product/service names and logos used in this publication are trademarks and trade names of Shimadzu Corporation or its affiliates, whether or not they are used with trademark symbol "TM" or "®". Third-party trademarks and trade names may be used in this publication to refer to either the entities or their products/services. Shimadzu disclaims any proprietary interest in trademarks and trade names other than its own.

For Research Use Only. Not for use in diagnostic procedures.
The contents of this publication are provided to you "as is" without warranty of any kind, and are subject to change without notice. Shimadzu does not assume any responsibility or liability for any damage, whether direct or indirect, relating to the use of this publication.